

## DH-PFB203W

### Water-proof Wall Mount Bracket



### Features

- Material: Aluminum
- Wall Mount Bracket
- Neat & Integrated design

### Specifications

Model	DH-PFB203W
<b>General</b>	
Material	Aluminum
Dimension (L x W x H)	160mmx 122mm x 76mm
Operating Temperature	-40°C~60°C
Humidity	0~90% RH
Load Bearing	1.0kg
Weight	0.5kg
Color	White
Applicable Model	Please see "Accessory Selection"

# DH-PFB203W

## Dimensions (mm)

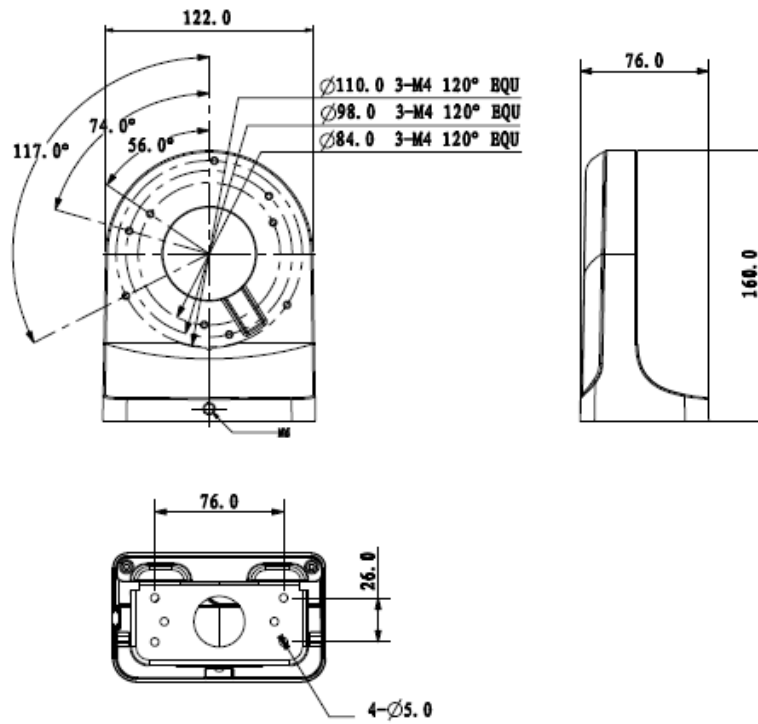

## Application

